



**NATIONAL COMMISSION FOR THE
CERTIFICATION OF CRANE OPERATORS (NCCCO)**

**PRACTICAL EXAMINATION
TEST SITE COORDINATOR
HANDBOOK**

- **DIGGER DERRICK OPERATOR**



BOARD OF DIRECTORS

This handbook reflects NCCCO's current policies at the time of publication. To be sure that you have the latest version of this book, see the Handbooks and Forms page on the NCCCO website.

PRESIDENT

J. Kerry Hulse

Deep South Crane & Rigging

VICE PRESIDENT

Peter Juhren

Morrow Equipment Co.

SECRETARY/TREASURER

Tim Watters

Hoffman Equipment

IMMEDIATE PAST PRESIDENT

Thom Sicklesteel

Leavitt Crane

CHAIRMAN, COMMISSIONERS

Ellis Vliet

Vinal George Bell

Cianbro Equipment

James T. Callahan

International Union of Operating Engineers

William (Bill) Davis

Zurich Services Corp.

Pete Laux

Kiewit Companies

CHIEF EXECUTIVE OFFICER

Graham J. Brent

National Commission for the
Certification of Crane Operators

NCCCO does not discriminate against any individual because of race, gender, age, creed, disability, or national origin.



This NCCCO certification program is accredited by the American National Standards Institute (ANSI) to ISO 17024 (General Requirements for Bodies Operating Certification Systems of Persons).



ISO/IEC 17024
Personnel Certification Body
#0756

Mobile, Tower, Overhead,
Articulating, and Service Truck Crane
Operator, Digger Derrick Operator,
Signalperson, Rigger Level I and
Level II, Crane Inspector, and Lift
Director Programs Accredited

Dear Practical Test Site Coordinator:

Welcome to the Practical Examination segment of the National Commission for the Certification of Crane Operators (NCCCO) digger derrick operator certification program.

The CCO Digger Derrick Operator Practical Examination was created as a fair, valid, and reliable assessment of the essential skills that digger derrick operators need to demonstrate to be certified by NCCCO to operate cranes. This program was developed by an NCCCO task force made up of industry experts—including operators, training directors, managers, supervisors, manufacturers—who together represent many thousands of hours of digger derrick experience. These volunteers gave freely of their time and expertise with the goal of improving the safety of all whose work brings them into contact with this equipment. NCCCO used its exam development expertise to guide the task force in establishing key elements of the program, including identifying essential skills, selecting tasks, standardizing test conditions, developing the scoring process, establishing reliability among tests, and creating flexible application and scheduling procedures. In concert with the task force, NCCCO also designed the Digger Derrick Practical Examiner Accreditation Program whereby NCCCO trains and accredits CCO-certified operators to administer CCO Practical Examinations.

Until recently digger derrick operator certification has been voluntary unless required by local jurisdictions or specific employers. However, in August 2010, the federal Occupational Safety and Health Administration (OSHA) enacted new national standards for cranes and derricks used in construction under 29 CFR 1926 Subpart CC. These new rules require that operators of most cranes and derricks when used in construction need to be either certified by an accredited crane operator testing organization such as NCCCO or qualified through an audited employer program. Section 1926.1427 of the new rule describes operator certification/qualification requirements. Option 1, which is anticipated to be the most commonly used, requires operators to be certified by a nationally accredited operator testing organization that tests operators through written and practical testing. Obtaining CCO certification from NCCCO meets all the requirements set forth by the new OSHA rule.

This handbook has been developed to provide you, the Practical Test Site Coordinator, with all the information you need to prepare for successful CCO practical examinations. As the Practical Test Site Coordinator, you play a critical role in the smooth administration of CCO exams on test day. ***It is vitally important that you study this entire handbook carefully before making any preparations for a practical test administration.*** The overview of the Practical Examination Process on page 1 and the summary of your responsibilities in the subsequent chapter are particularly important to understand the requirements for hosting and administering practical examinations. As you read through this handbook, you will find that it provides a large amount of detail on such aspects as digger derrick selection and configuration layout of the test site and construction of the Test Weight and other test site equipment. The validity and reliability of the test you are planning to administer depends on your following of these each requirements precisely. Failure to do so could result in your practical test being declared invalid and the need to start over.

NCCCO recognizes the commitment you have made and the resources you will allocate to hosting CCO practical examinations. We want your experience to be a positive and successful one, and we stand ready to assist you in reaching that goal. If, after reading this handbook, there is anything you do not fully understand or need clarifying, please call NCCCO at 703-560-2391 or email info@nccco.org. NCCCO staff will guide you through any aspects of the practical examination administration process that you would like explained in detail.

This page intentionally left blank



Table of Contents

Practical Examination Process	1
Hosting and Administering CCO Practical Examinations	3
Criteria for Test Sites	3
New and Probationary Test Sites	3
Test Site Coordinator	3
Practicing the Test Course.....	4
Practical Examiner	4
Proctors	4
Applying to Host a Practical Examination.....	4
Site Layout.....	4
Practicing the Test Course.....	5
Permanent Test Sites.....	5
Secure Test Sites	5
Candidate Photographs	5
Practical Examination Fees	5
Submitting Applications.....	5
Score Reporting	5
Mentor Program	6
Audit Program	6
Test Site Coordinator Forms	7
Test Site Application—Digger Derricks	9
Test Site Coordinator Agreement—Practical Examinations	10
Permanent Test Site Application.....	11
Candidate Application—Digger Derrick Operator Practical Exam	13
Practical Test Administration Summary Form	15
Detailed Score Report Request Form	17
Security Requirements Report	19
Test Site Coordinator Instructions	21
Test Site Setup	23
Pole Barrier Construction.....	25
Digger Derrick CAD Decision Tree	26
Sample Test Site Layout (CAD).....	27
Test Site Layout Instructions	28
Digger Derrick Selection and Setup	29
Photographs	32
Ready Reference Checklist.....	34
Site Report.....	35
Digger Derrick Report.....	39
NCCCO Information Release Policy.....	41
Summary of Changes	42

This page intentionally left blank



Practical Examination Process

FOUR OR MORE WEEKS BEFORE THE PRACTICAL EXAM...

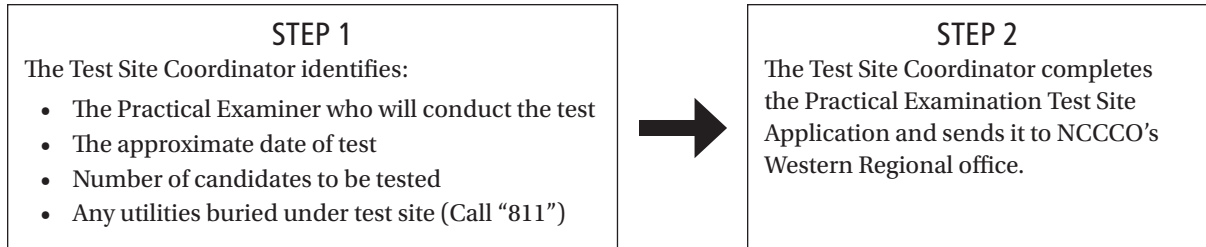

TWO OR MORE WEEKS BEFORE THE PRACTICAL EXAM...

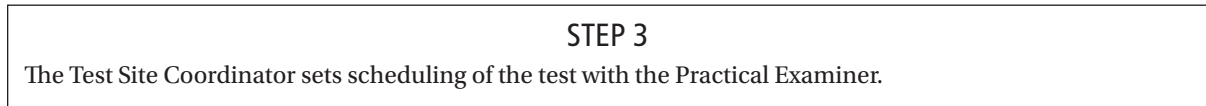

ONE OR MORE DAYS BEFORE THE PRACTICAL EXAM...

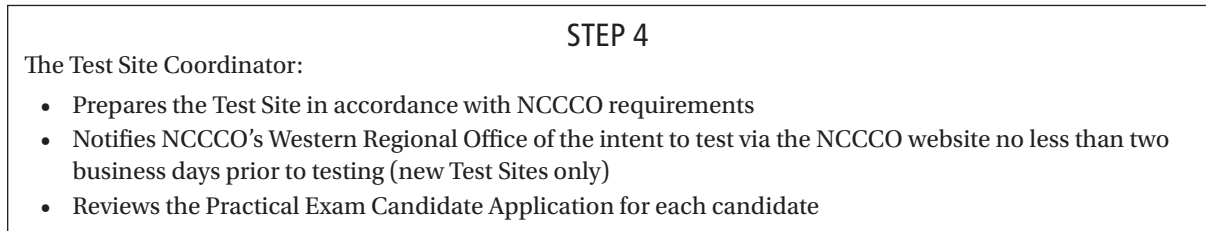

ON THE DAY OF THE PRACTICAL EXAM...

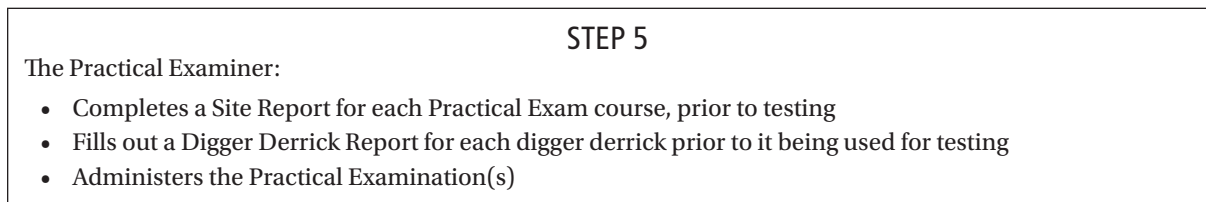

AFTER THE PRACTICAL EXAM...

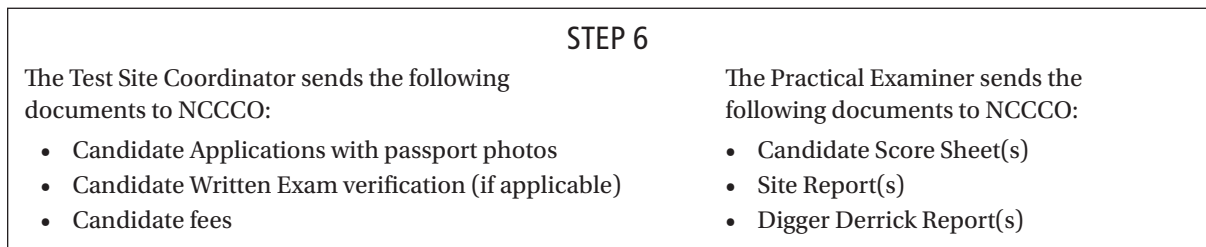

WITHIN 12 BUSINESS DAYS AFTER RECEIVING THE NECESSARY DOCUMENTS...

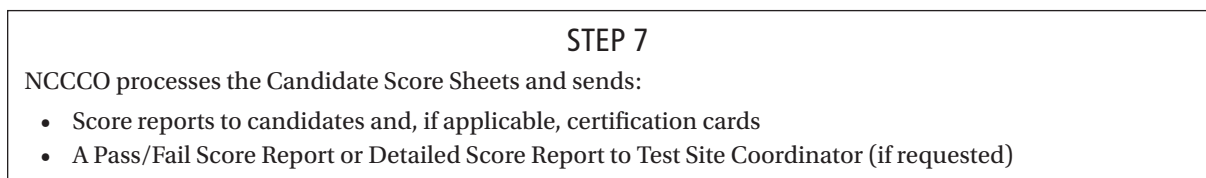

This page intentionally left blank



Hosting and Administering CCO Practical Examinations

Facilities seeking to serve as NCCCO Practical Exam Sites must meet all the following criteria for hosting a Practical Exam. If the facility meets the stated criteria, NCCCO will provide all the information necessary to schedule Practical Examinations.

CRITERIA FOR TEST SITES

Each Practical Exam Test Site facility must arrange to have on site the following:

- A designated Test Site Coordinator
- An NCCCO Accredited Practical Examiner
- A designated Proctor(s) to assist the Practical Examiner during the test
- Digger derrick(s) that meet NCCCO requirements for the Practical Exam(s) to be given (All equipment used for NCCCO testing shall comply with minimum OSHA requirements; where OSHA does not apply ASME B30 will be used.)
- An area suitable for testing on the digger derrick(s) selected and ancillary equipment necessary for conducting the exam(s)
- An location suitable for the Pre-Test Briefing of exam candidates and a waiting area.

In addition, Practical Exam Test Sites must pay an annual \$50 registration fee at the time of application and before the first practical test of each calendar year thereafter. If running a variety of CCO exams at that location, only one Test Site fee is charged on an annual basis. Employers or organizations with more than one Test Site must pay a fee for each site. Candidate Score Sheets from exams conducted at Practical Exam Test Sites that have not paid the \$50 annual fee will not be processed.

Test Sites are established by the physical address where the equipment is located. Multiple companies and/or sites are not permitted to be established under the same address, although additional equipment can be added by submitting the appropriate Test Site Application(s) to NCCCO's Western Regional Office. Should a Test Site need to become inactive or remove equipment, it must provide the following information to NCCCO in writing:

- PE Site Number
- Company Representative
- Company
- Contact information (phone and email)
- Company Representative signature

No site will be discontinued without this documentation.

Any Practical Exam Test Sites that become inactive (i.e., do not pay their annual test site fee) will be placed in probationary status (see below) and must follow the requirements for new test sites should they want to become approved again in the future.

NEW AND PROBATIONARY TEST SITES

For all new test sites and for 12 months after their first test administration, all new NCCCO Practical Exam Test Sites are conferred "probationary" status. The purpose of this probation is to monitor new test sites and ensure that they are following NCCCO's policies and procedures. These procedures include proper notification of testing, proper cancellation, and cooperation in the audit process.

Probationary test sites are required to provide notification via the NCCCO website at <http://nccco.org/login> no less than two business days prior to any test administration. Changes or cancellations to testing plans are subject to the same notification requirement. Once a site has provided test notification to NCCCO, that will be considered intent to test on that day and the site may be audited even if no testing occurs.

After a 12-month time frame, a probationary test site's history is reviewed to ensure that it has followed NCCCO's policies and procedures, including notification procedures. If a test site has not been providing proper notification, the probationary period will be extended at six-month intervals until such time that the policies and procedures have been properly followed.

TEST SITE COORDINATOR

The person designated by the host company or organization to liaise with NCCCO on test administration matters is known as the *Test Site Coordinator*. The Test Site Coordinator is responsible for the following:

- Preparing a test area in accordance with the directions in the Test Site Setup, Test Site Layout Instructions, and Test Site Layout (CAD) provided by NCCCO for the digger derrick type to be tested on
- Preparing test equipment in accordance with the directions provided under Digger Derrick Selection and Setup
- Scheduling candidates to take the Practical Exam, and informing them of their test date, location, and time
- Liaising with the Practical Examiner and NCCCO in all aspects of test preparation and administration

- Remaining at the Test Site throughout each test administration (or a designated representative)
- Have a direct email address to receive email notifications from NCCCO (this may not be a shared address)

Test Site Coordinators are also responsible for ensuring that all candidates and proctors meet NCCCO's personal protective equipment (PPE) policies, which at a minimum meet OSHA requirements.

All Test Site Coordinators and their designated representative are required to submit a completed Test Site Coordinator Agreement form (page 11) to the NCCCO Western Regional Office.

NCCCO periodically emails Information Bulletins to all Test Site Coordinators containing clarifications and updated policies. To remain in good standing, Test Site Coordinators are required to abide by the information contained therein.

PRACTICING THE TEST COURSE

Practicing the Practical Exam on or before the day of the test is permitted with the approval of the Test Site Coordinator for that site.

PRACTICAL EXAMINER

Practical Examinations are conducted by NCCCO-accredited Practical Examiners. NCCCO does not assign a Practical Examiner for your site; you can search a directory of accredited Practical Examiners available for hire on NCCCO's website at www.nccco.org/pe-for-hire. Practical Examiners must have an email address as a condition of accreditation.

Examiners may test only one candidate on one digger derrick at one time. Thus, testing a candidate (or several candidates, in turn) on one digger derrick, requires only one Practical Examiner. Testing two candidates simultaneously on separate digger derricks would, however, require two Practical Examiners, and so on.

If you need assistance on selecting a Practical Examiner, contact NCCCO.

Only Practical Examiners are permitted to request official Candidate Score Sheets from NCCCO. These must be requested or ordered online at least two weeks prior to the intended test date.

PROCTORS

Proctors are volunteers who assist the Practical Examiner in administering exams. The Test Site Coordinator

is responsible for assigning one Proctor per Practical Examiner to assist during the test. Proctors are under the direction of the Practical Examiner during the test administration. Candidates waiting to take the Practical Exam are permitted to serve as Proctors during Practical Exams.

APPLYING TO HOST A PRACTICAL EXAMINATION

When the Test Site Coordinator is ready to schedule a test, he/she must submit to NCCCO a completed Test Site Application.

NCCCO Practical Test Sites are registered by the host company for which the services are being provided, not the training company or the Practical Examiner.

The Test Site Application shall be filled out under the company's information for which the services are being provided (*not* the training company). All contact information (including an email address for the company contact person) *must* be provided. The training representative is *not* an acceptable contact person.

As illustrated on page 1, Test Site Application(s) should be sent, along with all additional requested materials, to NCCCO no later than four weeks prior to the desired test date. Note that all the information requested must be included; incomplete applications cannot be processed.

Once the application has been approved, NCCCO will send the layout of the Test Site and digger derrick setup, including a CAD Test Site Plan. NCCCO will email the CAD directly to the host company representative and the Test Site Coordinator.

SITE LAYOUT

Using the information NCCCO provides, including the Test Site Layout (CAD) and the instructions contained in this handbook, the Test Site Coordinator should prepare the digger derrick and lay out the Test Site.

Before the Practical Examiner can begin testing, he/she will verify the test site has been laid out correctly. Copies of the Site Report and Digger Derrick Report are provided in this handbook. NCCCO encourages Test Site Coordinators to use these reports to check that all items are in order before the Examiner arrives. This will expedite the Examiner's verification of the Test Site.

For permanent practical Test Sites, the requirement for a site inspection prior to each test may be waived. This option is available only to Test Sites where there has been no change in test digger derrick, test site/location, and Test Site Coordinator in the last six months. If it has been more

than six months since the last full Site Report was submitted, another full Site Report must be submitted.

*If the Test Site Coordinator requests a **Test Site Report Waiver**, the Examiner must have the Test Site Coordinator sign a statement on the last page of the Site Report attesting that all the requirements for such a waiver have been met.*

PRACTICING THE TEST COURSE

NCCCO discourages the use of authorized test courses for practice purposes. No CAD will be issued for a “practice” purpose only. Those wishing to establish a test course for practice purposes may use the Sample CAD provided in this handbook. Practicing the Practical Exam on or before the day of the test is permitted, however, with the approval of the site’s Test Site Coordinator.

PERMANENT TEST SITES

Practical Test Sites that test on a regular basis may become permanent Practical Test Sites. For such sites, the requirement for a site inspection prior to each test may be waived. This option is available only to test sites where there has been no change in test crane, test site/location, and Test Site Coordinator in the last 12 months.

An annual full site report is required for permanent test sites.

Use the Permanent Test Site Application in this handbook to apply for Permanent Test Site status. Probationary test sites may not apply.

SECURE TEST SITES

Test sites with limited access and/or enhanced security protocols that might interfere with the ability of testing personnel and/or NCCCO staff and Auditor to enter are required to indicate on their Test Site Applications that they are secure sites. They must also complete the enclosed Security Requirements Report and provide any associated documentation (such as the site’s formal security policy), all of which should be submitted along with the Test Site Application. All Secure Test Sites—including permanent Test Sites—must submit completed Security Requirement Reports annually.

VERIFYING CANDIDATE ELIGIBILITY

Candidates must pass both a written exam and a practical exam in the category(s) they wish to be certified in. Candidates have 12 months after they pass the first Exam (written or practical) in which to take and pass the corresponding written or practical exam in the same category. Candidates may take their written and practical Exams in either order. For example, a candidate passing the Digger

Derrick Operator written exam would have 12 months to pass the Digger Derrick Operator practical exam.

CANDIDATE PHOTOGRAPHS

All candidate applications must be accompanied by a color, head-and-shoulders photograph of the candidate without hat or sunglasses. Test Sites equipped with digital photographic equipment are encouraged to submit candidate photographs to NCCCO in digital format via email or CD.

PRACTICAL EXAMINATION FEES

Examination fees for the practical examination are as follows:

- Digger Derrick Operator Practical Exam (*new candidate*)..... \$60
- Digger Derrick Operator Practical Exam (*current CCO-certified Mobile Crane Operator, or new candidate registering for Mobile Crane Operator exams at the same time*)..... \$50

The appropriate fees must be submitted with the practical exam application through the Test Site Coordinator. The same fees apply for retest exams.

SUBMITTING APPLICATIONS

Once testing is completed, the Test Site Coordinator must send to NCCCO via email or overnight/second-day courier:

- Candidate applications with photos
- Candidate fees

SCORE REPORTING

All candidates are mailed a report of their performance from NCCCO approximately 12 business days after receipt of the Candidate Score Sheets from the Practical Examiner.

Test Site Coordinators are automatically sent at no charge a Pass/Fail Score Report for all candidates testing at their sites.

Test Site Coordinators may also request a Detailed Score Report for all candidates by completing the appropriate form in this handbook and submitting it, along with a \$50 processing fee, to NCCCO when returning test administration materials for each administration. **Note that all requests for Detailed Score Reports must include the release signature of each candidate.**

MENTOR PROGRAM

Practical Test Sites testing for the first time are encouraged to request a Mentor from NCCCO. Mentors are NCCCO-

accredited Practical Examiners who have experience in laying out Test Sites and who have been approved as Mentors by NCCCO's Practical Exam Management Committee.

Mentors are volunteers who receive no compensation from NCCCO for their services. However, Test Sites may negotiate fees with Mentors for test site setup and/or Practical Exam guidance services. Practical Test Sites interested in having a Mentor attend their site should contact NCCCO.

AUDIT PROGRAM

NCCCO conducts audits of Test Sites and/or Practical Examiners in accordance with the accreditation requirements of the American National Standards Institute (ANSI).

Test Sites and/or Practical Examiners are selected for audits on the basis of a variety of criteria, including random selection, in response to issues reported by candidates, unusually high or low pass rates, new Test Sites, or probationary Examiners.

Once a site has been selected for an audit, the Test Site Coordinator or company representative from the site may be notified by letter from NCCCO prior to the scheduled test day. In addition, the auditor will contact the Test Site Coordinator or company representative to verify the testing date and the site address. Unannounced audits may also be conducted.

It is a condition of Practical Examiner accreditation and Test Site status that all Test Site personnel, including the Test Site Coordinator, Practical Examiner, and Proctor, cooperate fully with the NCCCO auditor during the audit process.

Practical Examiners who have been audited and have been notified that an additional audit is required, will be responsible for the expenses incurred by NCCCO for the additional audit. Any practical exams conducted by the Examiner will not be scored until NCCCO has been reimbursed for the incurred expenses.



Test Site Coordinator Forms

DIGGER DERRICK OPERATOR

- **Test Site Application**
- **Test Site Coordinator Agreement**
- **Permanent Test Site Application**
- **Candidate Application—Practical Exam**
- **Practical Test Administration Summary Form**
- **Detailed Score Report Request Form**
- **Security Requirements Report**

This page intentionally left blank



Test Site Application

PRACTICAL EXAMINATION—DIGGER DERRICK OPERATOR

Please type or print neatly.

HOST COMPANY REPRESENTATIVE		TEST SITE NUMBER			
HOST COMPANY NAME		COMPANY REP EMAIL			
HOST COMPANY MAILING ADDRESS					
CITY		STATE	ZIP	COUNTRY	
COMPANY REP OFFICE PHONE			COMPANY REP MOBILE PHONE		
TEST SITE ADDRESS (Physical address of where the crane(s) will be set up; P.O. Boxes not acceptable)					<input type="checkbox"/> This is a Secure Test Site. (Submit completed Security Requirements Report.)
CITY		STATE	ZIP	COUNTRY	
CHECK BOXES AS APPROPRIATE					
<input type="checkbox"/> \$50 Site Fee for _____ (year) enclosed		<input type="checkbox"/> \$50 Site Fee for _____ (year) already paid		<input type="checkbox"/> This is my first test administration	
TEST SITE COORDINATOR NAME			TEST SITE COORDINATOR PHONE		
TEST SITE COORDINATOR EMAIL					
PRACTICAL EXAMINER NAME			PRACTICAL EXAMINER EMAIL		

The Test Site Coordinator or Company Representative assumes total responsibility for the following items:

1. Selection of cranes/digger derricks and verification that at all times during the testing process they are in compliance with federal and state OSHA requirements and the current ASME B30 standard
2. Verification that candidate's application for the Practical Exam is complete
3. Abiding by NCCCO Practical Test Site Audit requirements

SIGNATURE	DATE
-----------	------

METHOD OF PAYMENT FOR TEST SITE FEE

Do not send cash.

Personal check enclosed
 Employer check enclosed
 Money order enclosed
 Please do not staple your check or money order.

If paying by credit card, please complete the following information:

CREDIT CARD NUMBER												EXPIRATION DATE								
NAME (Print as it appears on card)											SIGNATURE (on card)					SECURITY CODE*				

* Three- or four-digit code located on the card.

Email credit card receipt to: _____

Checks and money orders should be payable to: NCCCO

Please send application and payments to:

National Commission for the Certification of Crane Operators
 Western Regional Office
 5250 S. Commerce Drive, Suite 100, Murray, UT 84107
 Phone: 801-363-2693 / Fax: 801-363-3806 / Email: ejones@nccco.org



Test Site Coordinator Agreement FOR CCO PRACTICAL EXAMINATIONS

Thank you for your application to be a Test Site Coordinator for CCO Practical Examinations. Test Site Coordinators play a critical role in the CCO examination process, from the initial site application, through the collection and submission of candidate applications to NCCCO, to serving as liaison with the Examiner on test day. To ensure a smooth administration of CCO certification exams, it is critical that Test Site Coordinators fulfill their duties in a competent and professional manner. Please review the following Agreement and sign below where indicated, acknowledging that you have read and understood this Agreement and that, should your application be successful, you agree to abide by all of its provisions. NOTE: If your employment or affiliation changes from the company/organization listed below, you must complete and execute this form anew.

As a Test Site Coordinator for CCO Practical Examinations, I certify and acknowledge that:

1. I will not disclose (nor cause to be disclosed) to anyone outside of NCCCO any confidential information I obtain as a result of my participation as a Test Site Coordinator in the CCO certification program, including, without limitation, the content of any examination.
2. I have read all applicable NCCCO policies and procedures, particularly those detailed in the Practical Examination Test Site Coordinator Handbook, and I agree to be bound by the same.
3. I have read NCCCO's Criteria for Practical Test Sites and agree to prepare all Test Sites in accordance with the general directions set forth therein.
4. I agree to provide authorized personnel with access to the Test Site on test day and to remain (or arrange for my designated representative(s) to remain) at the Test Site throughout the test administration.
5. If I arrange for one or more representatives to remain at the Test Site, I agree to explain the responsibilities and obligations of a Test Site Coordinator to such persons and to ensure their compliance therewith.
6. I understand that the site for which I am a Test Site Coordinator may be audited by NCCCO and that I am required to cooperate fully with the NCCCO Auditor.
7. I agree to meet all applicable deadlines for submitting the Practical Test Site Application and Data Sheet with all necessary supporting digger derrick documentation.
8. I agree to ensure that all Candidate Applications I submit are complete and in compliance with stated NCCCO policies and procedures, including any required payments.
9. I agree to pay any and all fees that are due in a timely fashion, including any additional fees I may incur by submitting incomplete or late applications.
10. I agree not to make, and not to knowingly allow any other person to make, any material misrepresentation or omission of fact in any document I submit to NCCCO.
11. I am acting on my own behalf and/or on behalf of the company or organization set forth below, and I am not acting to circumvent a prior NCCCO suspension or revocation.
12. I agree to conduct my affairs with NCCCO, any Examiner, clients, and candidates in a professional manner, according to accepted codes of business conduct.

I understand that non-compliance with any of these provisions may result in the revocation or suspension of my status as a Test Site Coordinator for CCO Practical Examinations. I agree that any questions or other matter arising under this agreement will be governed by and construed in accordance with the laws of the State of Virginia, without regard to choice of law rules. All actions and proceedings arising out of or relating directly or indirectly to this agreement will be filed and litigated exclusively in any state court or federal court located in the State of Virginia. I expressly consent to the jurisdiction of these courts.

SIGNED		DATE	
NAME		EMAIL	
COMPANY/ORGANIZATION			
ADDRESS			
CITY	STATE	ZIP	COUNTRY
TELEPHONE	CELL		

Please complete and submit to:

National Commission for the Certification of Crane Operators, Western Regional Office
 5250 S. Commerce Drive, Suite 100, Murray, Utah 84107
 Phone: 801-363-2693 / Fax: 801-363-3806 / Email: ejones@nccco.org



Permanent Test Site Application

PRACTICAL EXAMINATIONS

Please type or print neatly.

HOST COMPANY REPRESENTATIVE	PE TEST SITE NUMBER		
HOST COMPANY NAME			
HOST COMPANY MAILING ADDRESS			
CITY	STATE	ZIP	COUNTRY
HOST PHONE	HOST EMAIL		
TEST SITE ADDRESS (Physical address of where the crane(s) will be set up; P.O. Boxes not acceptable)			
CITY	STATE	ZIP	COUNTRY

Programs this site is registered for:

- | | | | | |
|---|---------------------------------|---------------------------------------|--|--|
| <input type="checkbox"/> Mobile | <input type="checkbox"/> Tower | <input type="checkbox"/> Overhead | <input type="checkbox"/> Articulating | <input type="checkbox"/> Service Truck |
| <input type="checkbox"/> Digger Derrick | <input type="checkbox"/> Rigger | <input type="checkbox"/> Signalperson | <input type="checkbox"/> Dedicated Pile Driver | <input type="checkbox"/> Drill Rig |

Cranes/digger derricks/dedicated pile drivers/drill rigs registered to this test site (operator programs only):

MAKE/MODEL	SERIAL NUMBER	MAX RATED CAPACITY (TONS)

If additional space is needed, please continue on the back side of this application.

The Test Site Coordinator or Company Representative assumes total responsibility for selecting equipment and verifying that at all times during the testing process the equipment is in compliance with federal and state OSHA requirements and current applicable industry standards.

By signing this application, I understand as Test Site Coordinator or Company Representative that this site is a permanent site in which the course, cranes/digger derricks/pile drivers/drill rigs, and Test Site Coordinator have not changed within the last 12 months. I also agree to abide by all NCCCO Practical Test Site policies and procedures. I understand that by signing this application, NCCCO will conduct an audit of the test site prior to the site being granted permanent status and that if at any time within 12 months the course, cranes/digger derricks/pile drivers/drill rigs,, or Test Site Coordinator change, this site will no longer be considered permanent and a new application for permanent status will be required.

SIGNATURE	DATE
NAME	EMAIL

Please complete and submit to:

National Commission for the Certification of Crane Operators, Western Regional Office
 5250 S. Commerce Drive, Suite 100, Murray, Utah 84107
 Phone: 801-363-2693 / Fax: 801-363-3806 / Email: ejones@nccco.org

**PERMANENT TEST SITE APPLICATION (CONT'D)
PRACTICAL EXAMINATIONS**

Test Site #: _____

Additional cranes/digger derricks registered to this test site (operator programs only):

MAKE/MODEL	SERIAL NUMBER	MAX RATED CAPACITY (TONS)



Candidate Application

PRACTICAL EXAMINATION—DIGGER DERRICK OPERATOR

Please type or print neatly.

FULL LEGAL NAME <small>(as shown on driver's license)</small>		First	Middle	Last	Suffix (Jr., Sr., III)
CCO CERTIFICATION NUMBER (if previously certified)		DATE OF BIRTH		CANDIDATE ID: <small>(if previously tested)</small>	
MAILING ADDRESS					
CITY			STATE	ZIP	COUNTRY
PHONE		CELL		EMAIL	
COMPANY/ORGANIZATION				COMPANY PHONE	
COMPANY MAILING ADDRESS					
CITY			STATE	ZIP	COUNTRY

INDICATE WITH A CHECK THE EQUIPMENT YOU WISH TO BE TESTED ON:

Digger Derrick

TEST SITE AT WHICH YOU INTEND TO TAKE THE PRACTICAL EXAMINATION

TEST SITE COORDINATOR NAME			PE SITE #:		
PHONE		EMAIL			
TEST SITE ADDRESS					
CITY			STATE	ZIP	COUNTRY

I declare that the foregoing statements and those in any required accompanying documentation are true. I understand and agree that my failure to provide accurate and complete information or abide by NCCCO's policies and procedures, including the Code of Ethics, shall constitute grounds for the rejection of my application, or denial or revocation of my certification. I understand that NCCCO reserves the right to verify any information in this application or in connection with my certification. I expressly consent to NCCCO's release of any information consistent with NCCCO's Information Release policy. I have received a copy of the NCCCO Candidate Handbook, have read it, and agree to be bound by it. I agree to be bound by all NCCCO policies and procedures, as they may be amended from time to time, including without limitation those posted at nccco.org. I attest that I have passed a substance abuse test conducted by a recognized laboratory service and agree to comply with NCCCO's substance abuse policy. I have passed a physical exam that complies with the ASME B30 standard for my certification designation and I will continue to comply with those requirements. I further attest that I am physically and mentally capable of safely operating equipment on the day of the Practical Examination. I understand and agree that any personal injury and/or property damage resulting from or caused in any way by my participation in the CCO Practical Examination is not and shall not be the responsibility of NCCCO. I understand that if at any point during my certification period I fail to meet any of the requirements outlined above, or if matters arise that can affect my capability to continue to fulfill certification requirements, I must report it to NCCCO immediately and agree to cooperate with any subsequent investigation regarding such matters.

CANDIDATE SIGNATURE	DATE
---------------------	------

CANDIDATE APPLICATION (CONT'D)

PRACTICAL EXAMINATION—DIGGER DERRICK OPERATOR

CCO CERTIFICATION CARD

Candidates who meet all the requirements for certification in any one designation are issued a certification card at no charge. Replacement and updated cards are available for an additional fee; see panel below.

Please email a digital color photo (without hat or sunglasses) to **photos@nccco.org** and label it with your full name and birth date. Enclose with your application form any required payment based upon the information listed below.

A 1 3/8" X 1 3/4" passport color photo may be substituted for a digital photo; if submitting a passport photo, please give it to your Test Site Coordinator.



PRACTICAL EXAMINATION FEE

Check the box(es) next to the Practical Exam category(s) for which you are registering:

- Digger Derrick Operator: \$60
- Digger Derrick Operator (*current CCO-certified Mobile Crane Operator, or new candidate registering for Mobile Crane Operator exams at the same time*): \$50
- Updated/replacement card: \$25

METHOD OF PAYMENT FOR CANDIDATE EXAMINATION FEES

Do not send cash.

<input type="checkbox"/> 	<input type="checkbox"/> 	<input type="checkbox"/> 	<input type="checkbox"/> Personal check enclosed	<input type="checkbox"/> Employer check enclosed	<input type="checkbox"/> Money order enclosed	<i>Please do not staple your check or money order.</i>
--	--	--	--	--	---	--

If paying by credit card, complete the following information:

CREDIT CARD NUMBER	<input type="text"/>	EXPIRATION DATE	<input type="text"/>
NAME (Print as it appears on card)	<input type="text"/>	SIGNATURE (on card)	<input type="text"/>
		SECURITY CODE*	<input type="text"/>

* Three- or four-digit code located on the card.

Email credit card receipt to: _____

Checks and money orders should be payable to: **NCCCO**

Do not send this application to NCCCO. Give this application, along with payment and all necessary documentation, to your Test Site Coordinator on test day.



Practical Test Administration

SUMMARY FORM—ALL PROGRAMS

Please type or print neatly.

SUBMITTER'S NAME					
SUBMITTER'S CELL PHONE		SUBMITTER'S EMAIL		PRACTICAL EXAM SITE NUMBER	
PRACTICAL EXAM SITE LOCATION (STREET ADDRESS)					
CITY		STATE	ZIP	COUNTRY	
TEST SITE COORDINATOR NAME					
TEST SITE COORDINATOR CELL PHONE			TEST SITE COORDINATOR EMAIL		

Dates Testing Occurred (range) First date: _____ Last date: _____

Practical Examiner Name	Practical Examiner Accreditation Number

Number of candidates tested: _____

Number of Practical Exams administered: _____

Did you submit the Site Report? (Not required for Signalperson test administrations or permanent test sites)

- Yes No

Did you submit the Crane/Digger Derrick Report?
(Not required for Mobile Crane, Rigger, or Signalperson test administrations)

- Yes No

Did you submit all candidate applications and fees?

- Yes No

How are you submitting candidate photos? _____

Tests administered in which programs? (Check all that apply):

- Mobile Crane Operator
- Tower Crane Operator
- Overhead Crane Operator
- Articulating Crane Operator
- Digger Derrick Operator
- Service Truck Crane Operator
- Dedicated Pile Driver Operator
- Drill Rig Operator
- Rigger
- Signalperson

PRACTICAL TEST ADMINISTRATION SUMMARY FORM (CONT'D)

LIST ALL CRANES/DIGGER DERRICKS/DEDICATED PILE DRIVERS USED DURING THIS ADMINISTRATION PERIOD:

Crane Type (e.g., "TLL")	Make	Model	Serial Number

PAYMENT SUMMARY

Total Examination Fees Enclosed: \$ _____



Updated CCO Card Fees Enclosed: \$ _____

Detailed Score Report Requested*: \$ _____ (\$50.00 if requested)

Total Fees Enclosed: \$ _____

**Separate Detailed Score Report Request Form must be submitted for processing. Payment may be provided either here or on separate form.*

METHOD OF PAYMENT (Do not send cash.)

 
 
 Personal check enclosed
 Employer check enclosed
 Money order enclosed
 Please do not staple your check or money order.

If paying by credit card, please complete the following information:

CREDIT CARD NUMBER	EXPIRATION DATE
NAME (Print as it appears on card)	SIGNATURE (on card)
SECURITY CODE*	

* Three- or four-digit code located on the card.

Email credit card receipt to: _____

Checks and money orders should be payable to: NCCCO

Please return this Practical Test Administration Summary Form along with all candidate applications, fees, photos, and score sheets to:

NCCCO—Testing Services Department
 1960 Bayshore Blvd.
 Dunedin, FL 34698

Phone: 727-449-8525
 Fax: 727-461-2746
 Email: jwarner@nccco.org



Detailed Score Report Request Form FOR CCO PRACTICAL EXAMINATIONS

If you wish to receive a Detailed Score Report on candidates taking the CCO examination(s), please fill out this form and submit it, along with a \$50 processing fee, to NCCCO when you return your test administration materials for each administration:

NCCCO—Testing Services Department
1960 Bayshore Blvd.
Dunedin, FL 34698

Phone: 727-449-8525
Fax: 727-461-2746
Email: jwarner@nccco.org

You must submit this form for each test administration. Scores are the property of the candidate, and his/her consent must be obtained before NCCCO can release the scores to a third party. Please have the candidate sign under the release statement below.

Please type or print neatly.

NAME OF REQUESTOR		PHONE	
COMPANY NAME		REQUESTOR'S EMAIL	
MAILING ADDRESS			
CITY	STATE	ZIP	COUNTRY
TEST SITE NUMBER	TEST DATE	SIGNATURE	

CANDIDATE RELEASE STATEMENT

Notice to Candidate: By signing this form, you are giving your permission to the National Commission for the Certification of Crane Operators (NCCCO) to release the details of your test scores directly to the person listed above as the "Requestor."

CANDIDATE NAME (printed)	DATE OF BIRTH*	CANDIDATE RELEASE SIGNATURE
1.		
2.		
3.		
4.		
5.		
6.		
7.		

*Date of birth required to assure correct candidate identification.

METHOD OF PAYMENT FOR DETAILED SCORE REPORT REQUEST

Do not send cash.

<input type="checkbox"/>		<input type="checkbox"/>		<input type="checkbox"/>		<input type="checkbox"/> Personal check enclosed	<input type="checkbox"/> Employer check enclosed	<input type="checkbox"/> Money order enclosed	<i>Please do not staple your check or money order.</i>
--------------------------	--	--------------------------	--	--------------------------	--	--	--	---	--

If paying by credit card, please complete the following information:

CREDIT CARD NUMBER	EXPIRATION DATE	SECURITY CODE*
NAME (Print as it appears on card)	SIGNATURE (on card)	

* Three- or four-digit code located on the card.

Email credit card receipt to: _____

Checks and money orders should be payable to: **NCCCO**

DETAILED SCORE REPORT REQUEST FORM (CONT'D)

TEST SITE NUMBER	TEST DATE	NAME OF REQUESTOR
------------------	-----------	-------------------

CANDIDATE RELEASE STATEMENT

Notice to Candidate: By signing this form, you are giving your permission to the National Commission for the Certification of Crane Operators (NCCCO) to release the details of your test scores directly to the person listed above as the "Requestor."

CANDIDATE NAME (printed)	DATE OF BIRTH*	CANDIDATE RELEASE SIGNATURE
8.		
9.		
10.		
11.		
12.		
13.		
14.		
15.		
16.		
17.		
18.		
19.		
20.		
21.		
22.		
23.		
24.		
25.		
26.		
27.		
28.		
29.		
30.		
31.		
32.		

*Date of birth required to assure correct candidate identification.



Security Requirements Report

PRACTICAL EXAMINATIONS

A secured test site is a site that requires additional security clearance or security procedures for off-site personnel. If the Test Site Application indicates that the test site is a secure facility, please complete this form and submit it with the Test Site Application.

Please type or print neatly.

SECURITY CONTACT REPRESENTATIVE		PE TEST SITE NUMBER (OBTAIN FROM TEST SITE COORDINATOR)	
HOST COMPANY NAME			
HOST COMPANY MAILING ADDRESS			
CITY	STATE	ZIP	COUNTRY
SECURITY CONTACT PHONE		SECURITY CONTACT EMAIL	
TEST SITE ADDRESS (Physical address of where the crane(s) will be set up; P.O. Boxes not acceptable)			
CITY	STATE	ZIP	COUNTRY

1. Does the site have a secured entrance? Yes No
2. If the site has multiple entrances, which entrance should testing personnel and/or NCCCO staff and Auditor use to access testing location? _____
3. What type(s) of credentials or proof of training are required to gain access to the site? _____
4. How much time is required for a security review? _____
5. Can security reviews be performed in advance of testing personnel and/or NCCCO staff and Auditor arriving at secure site? Yes No
6. Does the site have other site-specific requirements or protocols? (Describe below or attach written security policy.)

SECURITY CONTACT SIGNATURE	DATE
----------------------------	------

Please complete and submit to:

National Commission for the Certification of Crane Operators, Western Regional Office
5250 S. Commerce Drive, Suite 100, Murray, Utah 84107
Phone: 801-363-2693 / Fax: 801-363-3806 / Email: ejones@nccco.org

This page intentionally left blank



Test Site Coordinator Instructions

DIGGER DERRICK OPERATOR

- **Test Site Setup**
- **Pole Barrier Construction**
- **Digger Derrick CAD Decision Tree**
- **Sample Test Site Layout (CAD)**
- **Test Site Layout Instructions**
- **Digger Derrick Selection and Setup**
- **Photographs**
- **Ready Reference Checklist**
- **Site Report**
- **Digger Derrick Report**

This page intentionally left blank



Test Site Setup

DIGGER DERRICK OPERATOR

PRE-TEST CANDIDATE BRIEFING AREA

This area must be located so that waiting candidates are unable to observe testing procedures. It must be provided with:

- NCCCO candidate instruction materials, including a written description of the examination (Candidate Handbook) and copies of the Test Site Layout (CAD)
- Operator's manuals and load charts for all digger derricks to be tested on
- A DVD player and television or computer for candidates to watch the CCO Practical Exam video (up to 24 hours before the Practical Exam)
- A location suitable for the Pre-Test Briefing of exam candidates, to include:
 - Sufficient tables and chairs to seat candidates for the Pre-Test Briefing
 - Head table or podium at the front of the room
 - Registration table
 - Quiet, well-lit, surroundings with a comfortable temperature
 - Easy access to unlocked rest rooms stocked with sufficient supplies
 - Easy access to a water fountain
 - Large signs prominently posted to make candidates aware of the location of the test

CORRIDOR

The Corridor is composed of a PVC-pole barrier with one tennis ball placed on top of each pole.

POLES

Poles are made of 1½-inch, white PVC pipe (SCH 40), painted orange or red on top (see Pole Barrier Construction Diagrams, page 25). Some poles are 36 in. tall and others are 12 in. tall. One inside splice per 3 ft. pole is permitted but outside splices of PVC pipes are NOT permitted (see diagram, right).

The poles must be mounted on a pole base made of two ¾-inch, CDX-grade (or better) plywood glued together, cut 12 in. long with ends cut square. As an alternative to plywood, high density polyethylene (HDPE) or equivalent, may be used to construct the pole bases. This material must meet the following requirements:

- Weight: 5 lbs. (±10 percent)
- Nominal dimensions: 12 in. × 12 in. × 1½ in. (±½ in. thick)

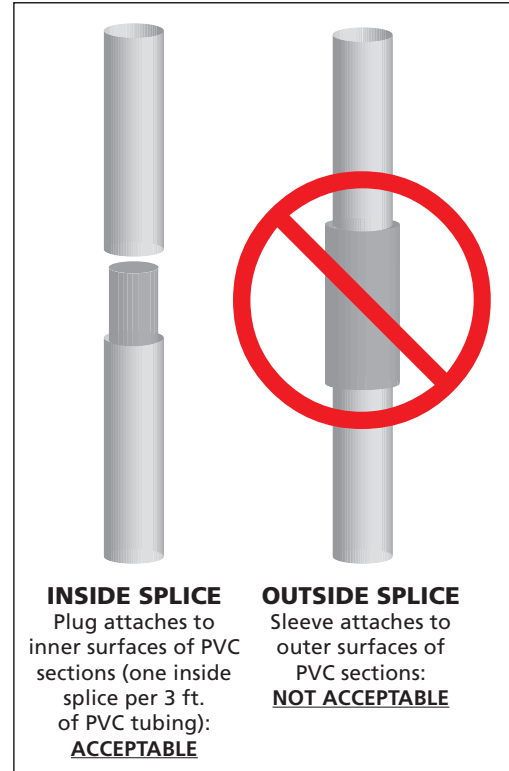

The weight must be spread evenly across the base. Pole bases may be coated with a protective finish if desired, so long as they continue to meet the stated design and construction parameters.

Pole bases must be placed as indicated on the Test Site Layout (CAD). A taut, longitudinal string line must be placed on the ground under the centerline of each pole base. A cut concrete line may be used in lieu of a string line.

To assist the Examiner and Proctor in restoring the Corridor between tasks, the tennis balls may be attached to the pole by means of 12 in. long nylon string. The string must be attached between 2 in. and 8 in. from the top of the pole and to the tennis ball as illustrated on page 25.

During the test, the string loops must face towards the outside of the corridor to avoid the string being snagged on the Test Weight.

If the string does become snagged during a test, the Examiner must stop the test, restore the corridor to its original condition, and direct the candidate to restart the task.

DESIGNATED AREAS

All designated areas must have outside dimensions as stated on the Test Site Layout (CAD) with a clearly marked inside line at least 2 in. wide and they must be located per the CAD. The suggested method of marking the designated areas is with thin, durable rubber mats that secure to the ground and are of a color that contrasts distinctly with the ground surface.

If marking circles or other parts of the course on plywood or mats, the borders must be marked with materials with a flat, uniform surface and a lip variance not to exceed 3/4 in. Any materials used may not interfere with the free movement of the pole bases.

LEVEL

All parts of the Test Site must be level and free of debris, stored materials, surface irregularities, or hazards such as overhead power lines that could interfere with test maneuvers. No obstructions may be within 5 ft. of a practical test course in any direction.



Pole Barrier Construction

DIGGER DERRICK OPERATOR

Assembled Pole Barrier

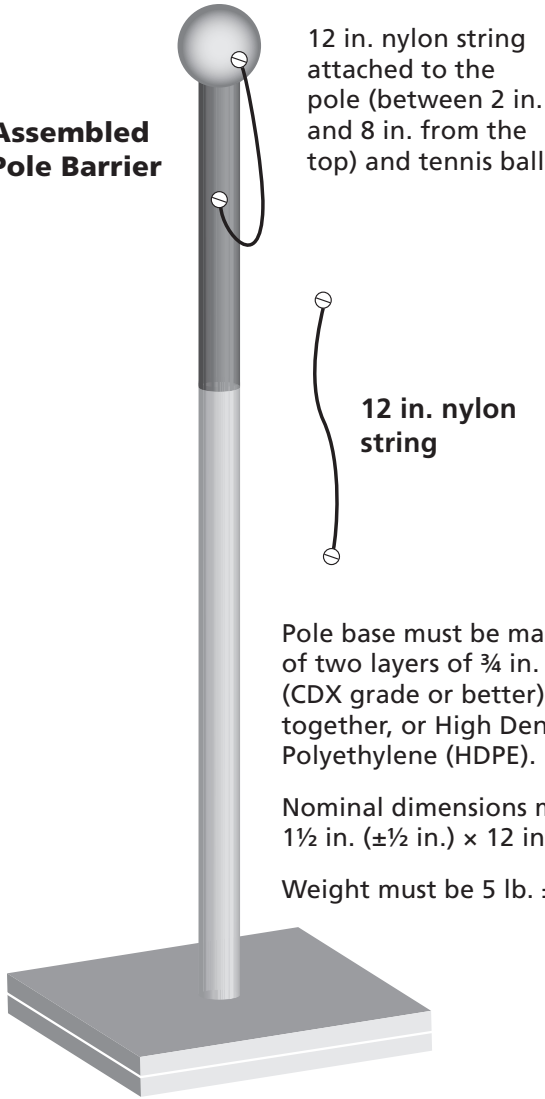

12 in. nylon string attached to the pole (between 2 in. and 8 in. from the top) and tennis ball

12 in. nylon string

Pole base must be made either of two layers of $\frac{3}{4}$ in. plywood (CDX grade or better) glued together, or High Density Polyethylene (HDPE).

Nominal dimensions must be $1\frac{1}{2}$ in. ($\pm\frac{1}{2}$ in.) x 12 in. x 12 in.

Weight must be 5 lb. $\pm 10\%$

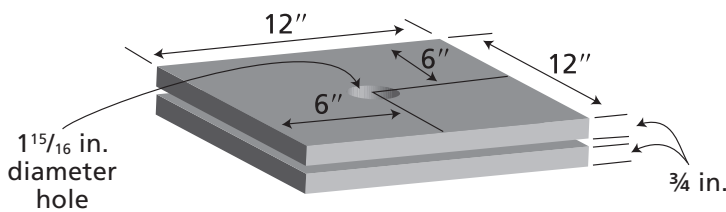

Two sheets of $\frac{3}{4}$ in. x 12 in. x 12 in. plywood (CDX grade or better)

12 in. Poles



Tennis Ball

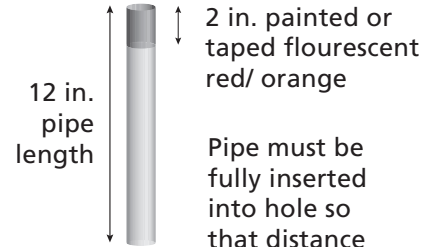

12 in. pipe length

2 in. painted or taped fluorescent red/ orange

Pipe must be fully inserted into hole so that distance between top of pole to ground is 12 in.

1½ in. PVC SCH 40 Pipe

Standard 36 in. Poles



Tennis Ball

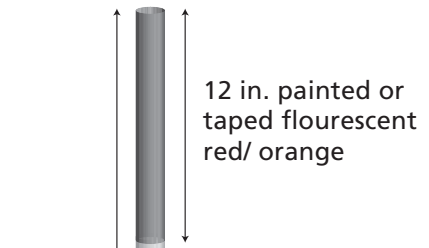

36 in. pipe length

12 in. painted or taped fluorescent red/ orange

Pipe must be fully inserted into hole so that distance between top of pole to ground is 36 in.

1½ in. PVC SCH 40 pipe



Digger Derrick CAD Decision Tree

Follow the decision tree below to determine which CAD to use for the digger derrick you will use for testing.

If you have any questions, contact NCCCO at 801-363-2693.

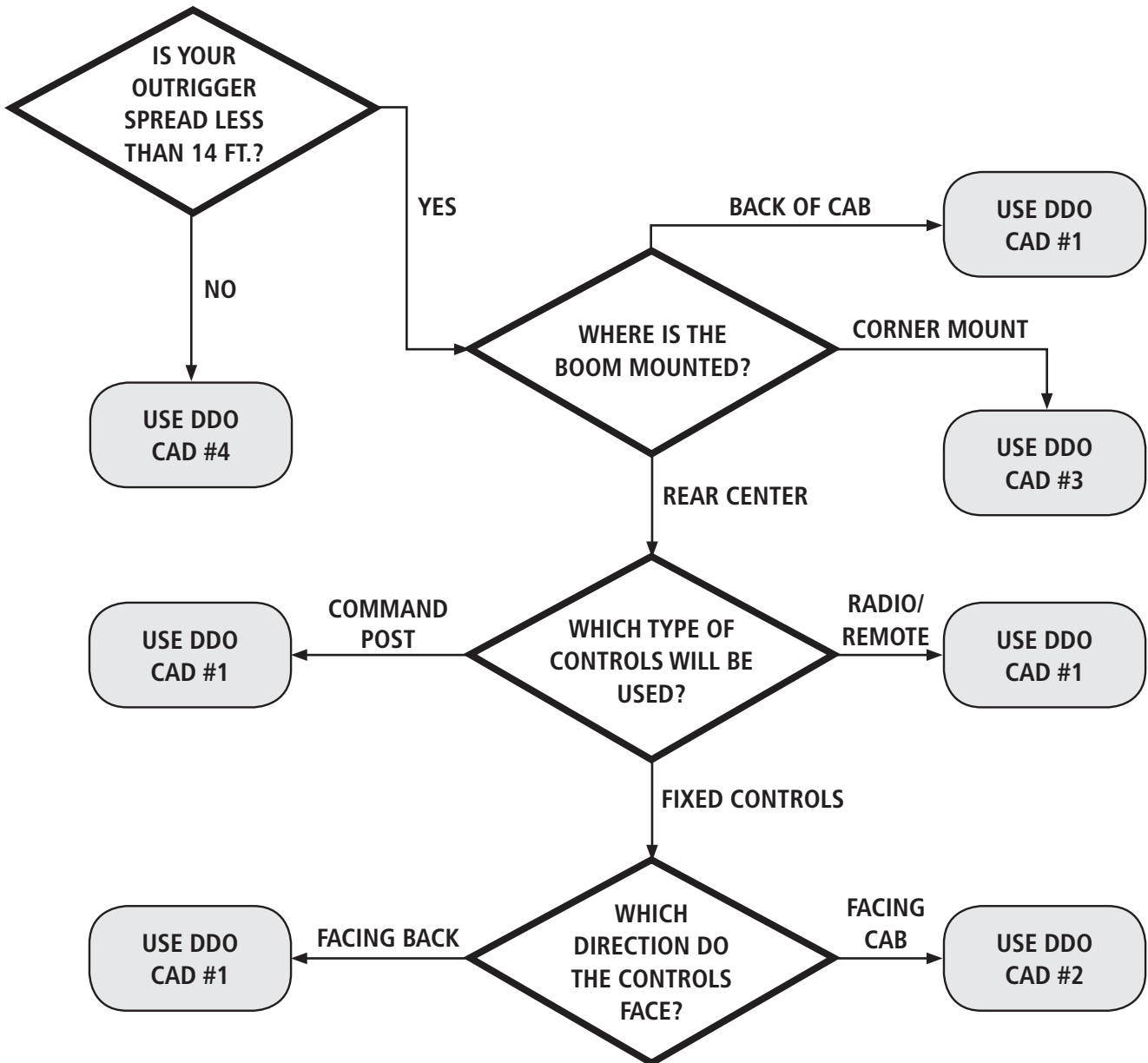



Sample Test Site Layout (CAD)

DIGGER DERRICKS

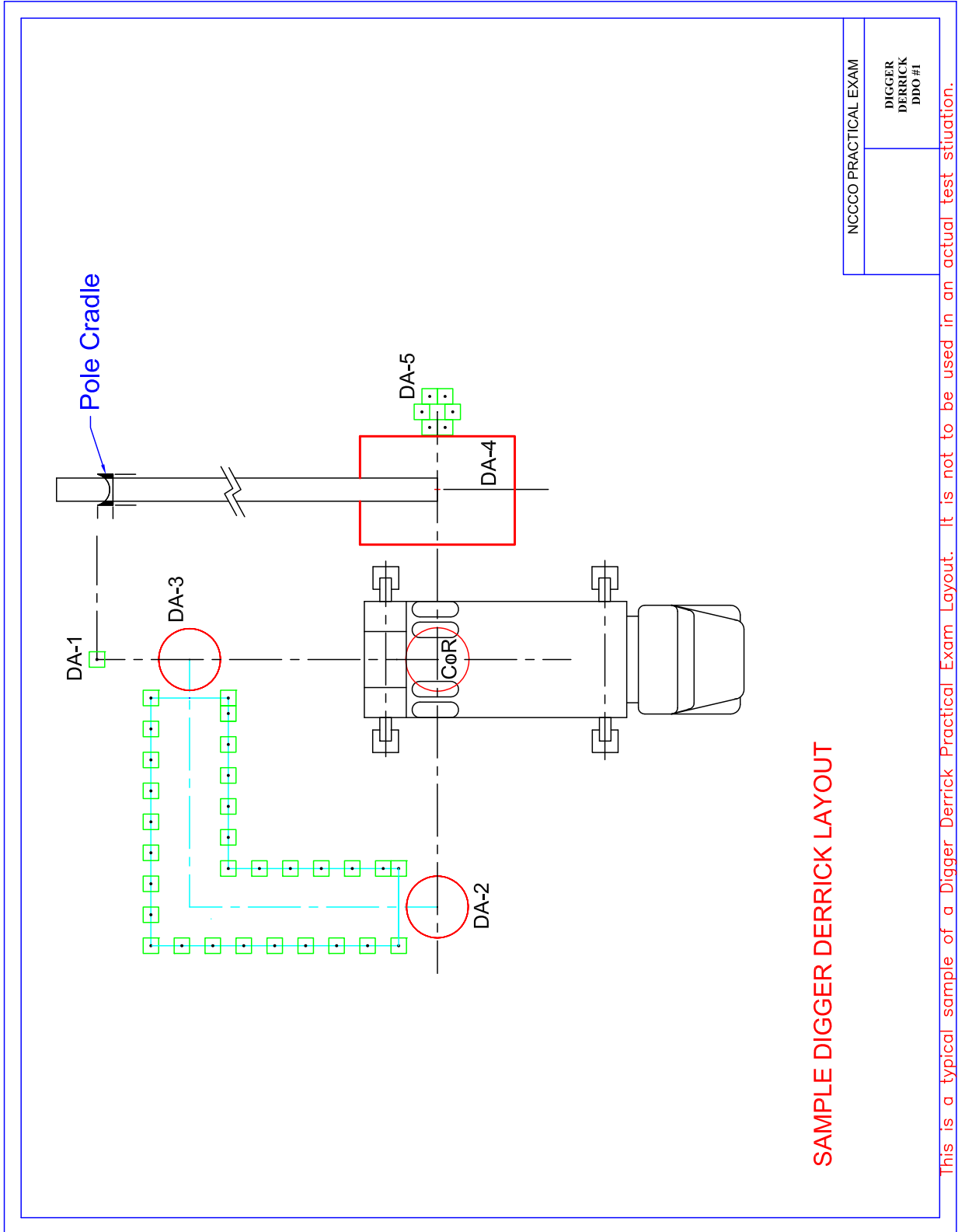

SAMPLE DIGGER DERRICK LAYOUT

This is a typical sample of a Digger Derrick Practical Exam Layout. It is not to be used in an actual test situation.



Test Site Layout Instructions

DIGGER DERRICKS

Using the CAD drawing and other information provided by NCCCO, it is the Test Site Coordinator's responsibility to lay out the test site. It is extremely important that all test equipment (corridor poles, Test Weight, and Designated Areas, etc.) be placed exactly as indicated on the CAD drawings. Failure to do so could result in the test administration being declared invalid and the need to start over.

Before the Practical Examiner can begin testing, he/she will verify the site is laid out correctly using the *Site Report*. Test Site Coordinators are strongly encouraged to use the *Site Report* form to verify that they have followed the site layout directions correctly. ***There are various ways to begin the process of laying out the Test Site, but we recommend the following procedure:***

	GENERAL LAYDOWN PROCEDURES	Verified site is clear of underground utilities. The course is based on the Center of Rotation (CoR) and intersecting lines that establish other key points.
1.	CHECK FOR OBSTRUCTIONS	Ensure that no obstructions that could interfere with the safe operation of the Digger Derrick are within 5 ft. of the test course in any direction. Select your CoR and set a nail.
2.	LAY DOWN COR TO DA-1 CENTERLINE	Measure 22 ft. from the CoR and set a nail for DA-1.
3.	LOCATE DA-3	Measure 16 ft. from the CoR along the line toward DA-1 and set a nail. Paint a 4 ft. OD circle with a minimum 2 in. wide line.
4.	LOCATE FC	Measure 26 ft., 2 in. from CoR and 18 ft., 8 in. from DA-3; set a nail at the intersection of these two measurements for the Far Corner (FC).
5.	LOCATE DA-2	Measure 16 ft. from CoR and 18 ft., 8 in. from FC; set a nail where these two measurements intersect. Paint a 4 ft. OD circle with a minimum 2 in. wide line.
6.	LOCATE DA-2 OCC	Measure 18 ft., 8 in. from CoR past DA-2 and 16 ft. from FC; set a nail where these two measurements intersect for the DA-2 Outside Corridor Corner (OCC).
7.	LOCATE DA-2 ICC	Measure 16 ft., 9 in. from FC and 5 ft. from the DA-2 outside corner; set a nail where these two measurements intersect for the DA-2 Inside Corridor Corner (ICC).
8.	LOCATE DA-3 OCC	Measure 18 ft., 8 in. from CoR past DA-2 and 16 ft. from FC; set a nail where these two measurements intersect for the DA-3 OCC.
9.	LOCATE DA-3 ICC	Measure 16 ft., 9 in. from FC and 5 ft. from the DA-3 outside corner; set a nail where these two measurements intersect for the DA-3 ICC.
10.	LOCATE CIC	Measure 11 ft. from DA-2 ICC and 11 ft. from the DA-3 ICC; set a nail where these two measurements intersect for the Corridor Inside Corner (CIC).
11.	SET STRINGS LINES	Attach a string line starting at one corner of the corridor and tie around the nails located at each corner.
12.	LOCATE THE POLE	The pole position is based on the operator's station and linked to a specific layout (see DDO CADs #1 through #4).
13.	LOCATE DA-4	Per CAD, measure from the CoR in line with DA-2; paint a 10 ft. × 7 ft. rectangle (outer dimensions) with a 2 in. wide line. Align the pole-butt.
14.	LOCATE DA-5	DA-5 is a series of poles centered around a point that measures 5 ft. from the center of DA-4 and is in line with the CoR. Use a pole/base on the center point of DA-5 and arrange the poles and bases around it. Align the two 12 in. poles facing the CoR.
15.	DIG THE HOLE	Dig a hole at least 5 ft. from the machine and course such that the auger can be retracted or extended to keep the auger plumb.
16.	POSITION THE DIGGER DERRICK	Move the Digger Derrick into position with the turntable centered directly over the location labeled as the CoR. Set the outriggers.



Digger Derrick Selection and Setup

DIGGER DERRICK SELECTION

Digger derricks used for testing must meet the following criteria:

- Must have a minimum boom radius of 27 ft.
- Must be equipped with pole guides
- Must be equipped with auger
- Recommended minimum test area: 90 ft. × 90 ft.

COMPLIANCE

All digger derricks used on CCO practical examinations must be in compliance with federal and state OSHA requirements and the current A10.31 standard.

TASK CHAIN

For Task 2, a piece of 3/8- or 5/16-inch chain, painted orange or red, is required; recommend using a minimum 6-inch diameter ring on one end so that it can be quickly and easily attached to and detached from the load hook. The length of the chain measured from the bottom of the hook must be 3 ft. (See diagram, right.)

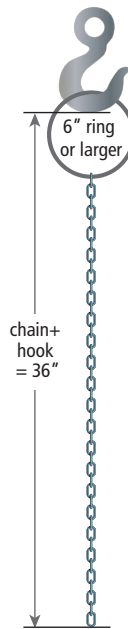

Task Chain

UTILITY POLE AND SLING

The utility pole used for the test must be 35–45 ft. long and have a maximum butt diameter of 18 in. The pole must have an area marked on it for an appropriate pick point. Rigging must be a synthetic sling of appropriate capacity with a choker hitch and a maximum of 36 in. from choke point to hook. The cradle must have a minimum of 3 in. ground clearance.

DETERMINING POLE PICK POINT

To determine pick point for utility pole, attach the sling slightly above the midpoint so that the butt end outweighs the top end. Mark the pole so that the rigging can be properly placed for each candidate

AUGER

The auger must be in proper working order and able to dig into the ground's composition. The auger strap must also be inspected to ensure that it is in proper working order.

OUTRIGGERS

All outriggers must be fully extended and set. This includes all main and auxiliary outriggers if so equipped.

BLOCKING

Matting or cribbing installed if necessary to provide a sound foundation for the digger derrick. A spirit level (minimum length 1 ft.) must be available for the candidates to verify the digger derrick's level condition prior to beginning their testing.

CONTROLS

Test digger derrick may be operated from a fixed control station, command post (top seat) control station, or radio/remote control. All controls must be in working condition. For remote controls, ensure batteries are fully charged and enough extra batteries are available to complete all scheduled tests.

MANUAL EXTENSIONS/JIBS

No manual extensions or jibs may be used during the exam.

TEST WEIGHT RIGGING

The Test Weight rigging used to connect the Test Weight to the digger derrick must meet the following criteria:

- Total rigging length 2–4 ft. (3 ft. recommended); total rigging length is measured from load-bearing point to load-bearing point
- Two or three sling legs
- Recommend use of bridle
- Recommend sling angles of 60 degrees (30 degree minimum)
- Can be easily attached and detached from the digger derrick
- Meets current applicable industry standards

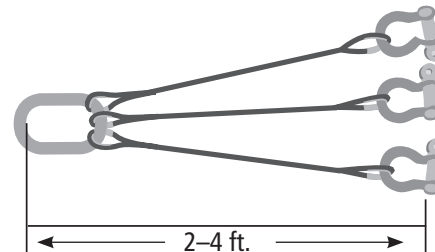

TEST WEIGHT

The gross load (which includes the weight of the Test Weight and any rigging and ancillary equipment in place on the digger derrick) must not exceed 75 percent of the rated capacity at the farthest corner (FC) indicated on the Test Site Layout (CAD). See Digger Derrick Report for more information.

These weights must be verified by a weight ticket, crane's load indicating device (LMI, RCI, RCL), or other type of certification documenting the actual load weight. This document must be presented to the Examiner.

The Test Weight must:

- Weigh a minimum of 400 lb.
- Be cylindrical in shape, with the same diameter from top to bottom and no protruding edges
- Have a continuously smooth surface from top to bottom
- Have a diameter of 2 ft.
- Have a height between 2 ft. and 4 ft.
- Have a chain extending from the bottom center of the Test Weight; the chain must be a 3 ft. length of 3/8- or 5/16-inch chain, orange or red
- Have two or three points of attachment on the top of the Test Weight with picking ears mounted inside the Test Weight, or if mounted on the outside of the Test Weight the bottom of ears are at least 3 ft. 6 in. above the bottom of the weight

TEST WEIGHT CONSTRUCTION

So long as the requirements for Test Weight design are adhered to, Test Site Coordinators are free to select the most convenient materials and methods available to them.

Pipe has a major advantage over other materials in that it has a smooth surface and is perfectly cylindrical, two of the main requirements for NCCCO Test Weights.

If the weight of the Test Weight is expected to change from time to time to accommodate different types and sizes of digger derricks, consider selecting steel pipe and filling it with removable material (e.g., steel slugs) that can be varied according to specific test requirements. The following diagram and chart are provided for Test Sites selecting this option.

PIPE DIAGRAM

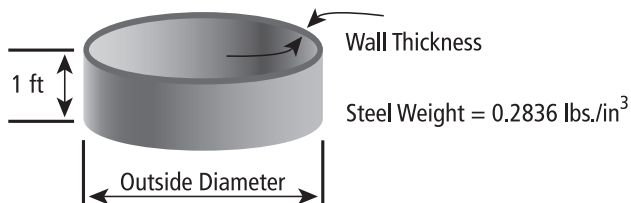

The *Pipe Weight Thickness Chart* provides weights for given steel pipe wall thicknesses and outside diameters.

PIPE WEIGHT THICKNESS CHART (WEIGHT FOR 1 LINEAR FOOT OF PIPE)

OUTSIDE DIAMETER	PIPE WALL THICKNESS			
	1/4"	3/8"	1/2"	3/4"
2'0"	63 lbs.	95 lbs.	126 lbs.	186 lbs.

For pipe lengths longer than 1 ft., multiply the weight given in the table times the pipe length in feet.

Example: Pipe weight for a 2 ft. diameter × 3/4 in. wall thickness pipe × 3 ft. high = 186 lbs. × 3 ft. = 558 lbs.

All load-supporting components must be assembled in accordance with proper rigging practice and working load limits for hardware utilized.

Any test weight components that use fabricated structural components and are part of the load-supporting system must be designed and fabricated in accordance with minimum acceptable requirements and welding practices.

TYPICAL TEST WEIGHT CONSTRUCTION

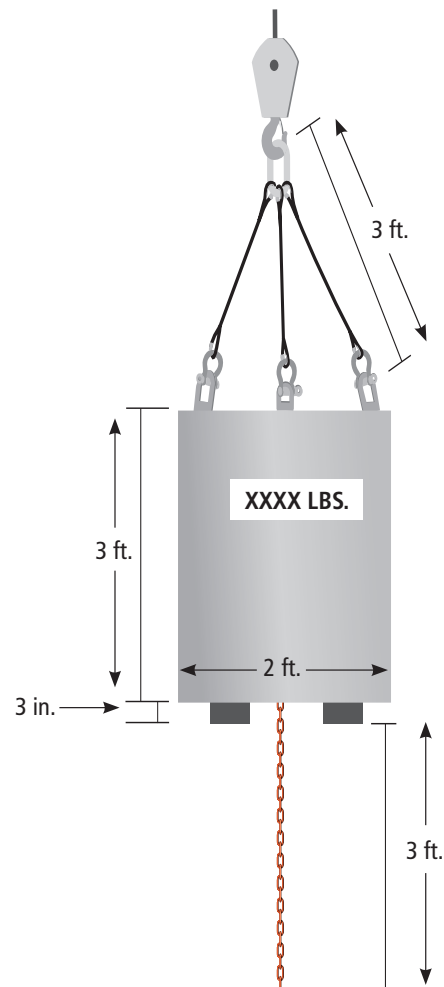

RECOMMENDED TEST WEIGHT DESIGN

NCCCO has some recommendations for construction of Test Weights suitable for use in CCO digger derrick Practical Exams. The Test Weight should have three attachment points, and the rigging should measure 2–4 ft. from load-bearing point to load-bearing point. The weight of the Test Weight should be adjustable, so additional weight can be added, as necessary. The chain should attach from the top and run through a tube to come out through the bottom. Finally, there should be four 3 in. tall rubber feet on the bottom of the Test Weight.

RECOMMENDED TEST WEIGHT CONSTRUCTION





Photographs DIGGER DERRICKS



36 in. Corridor Poles

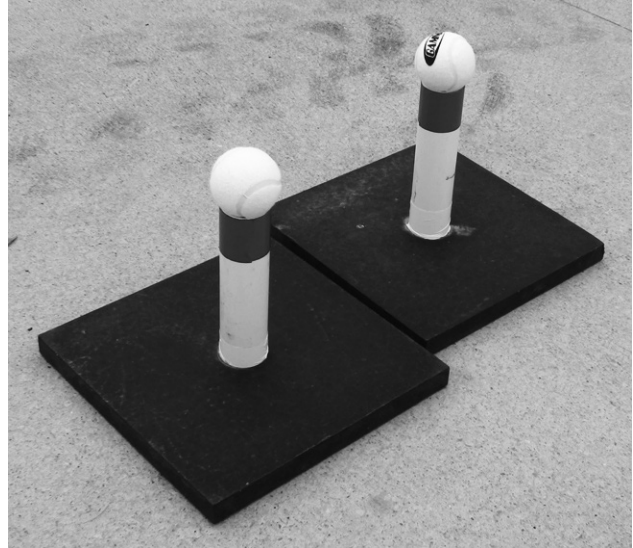

12 in. PVC Poles

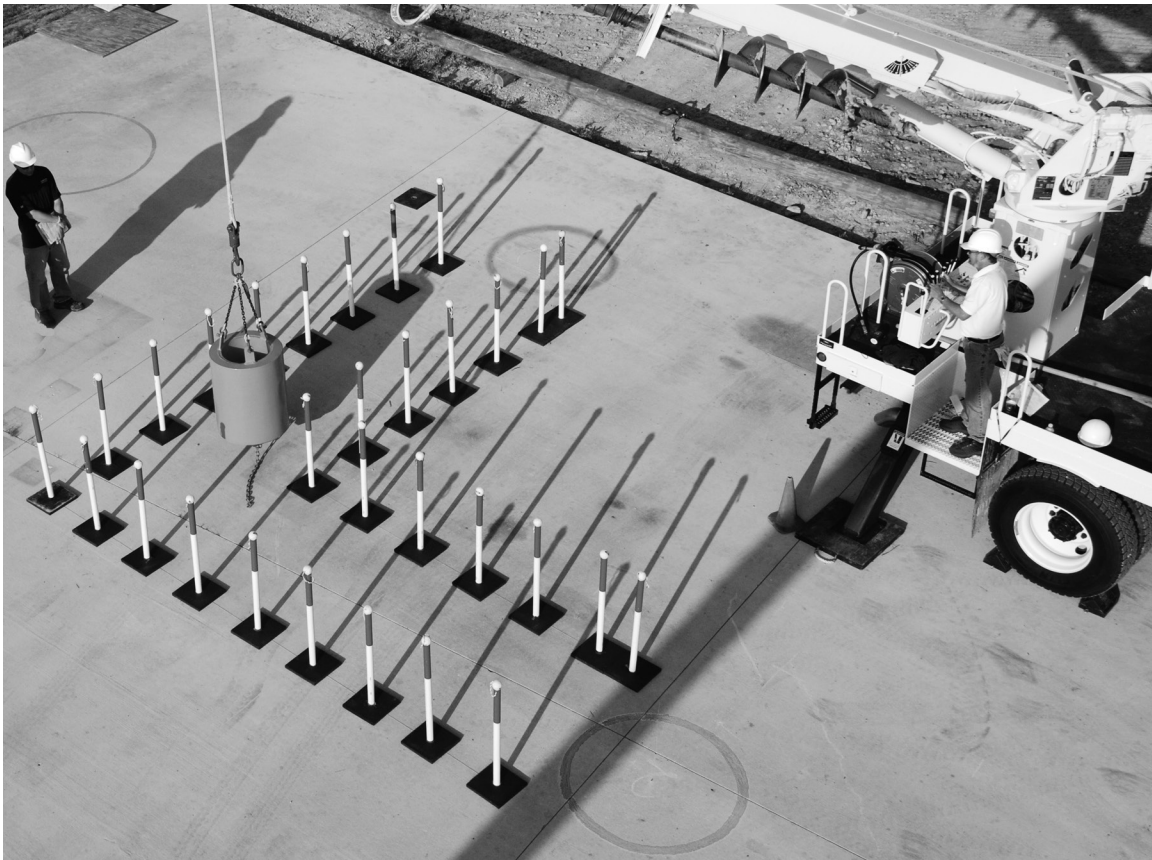

Test Weight and Corridor



PHOTOGRAPHS (CONT'D) DIGGER DERRICKS

TEST WEIGHT

One example of a suitable Test Weight is this 30 in. piece of 24 in. diameter pipe.

Any test weight components that use fabricated structural components and are part of the load-supporting system must be designed and fabricated in accordance with minimum acceptable requirements and welding practices.



Test Weight

MEASURING THE COURSE

All elements of the test site must be laid out in accordance with the Test Site Layout (CAD). The Test Site Coordinator is responsible for carefully checking all dimensions prior to the arrival of the Practical Examiner.



Pole

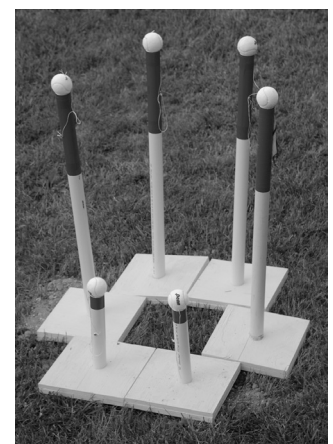

Designated Area 5



Ready Reference Checklist

DIGGER DERRICKS

YOU WILL NEED THE FOLLOWING FOR EACH DIGGER DERRICK TO BE TESTED ON:

- A Test Weight of minimum 400 lbs. including rigging—verified by a weight ticket, crane’s load indicating device (LMI, RCI, RCL), or other type of certification documenting the actual load weight available to the Examiner—cylindrical in shape, 2 ft. in diameter, and 2 ft.–4 ft. in height
- Length of 3/8- or 5/16-inch chain, orange or red, measuring 3 ft. long from the bottom center of the Test Weight
- Test Weight rigging has two or three sling legs (use of bridle recommended), 2–4 ft. in length (3 ft. recommended); recommend 60 degree sling angles (minimum 30 degrees required)
- Picking ears are mounted inside the Test Weight, or if mounted on the outside of the Test Weight the bottom of ears are at least 3 ft. 6” above the bottom of the weight
- 36 in. length of 3/8- or 5/16-inch chain, painted orange or red (recommend using a minimum 6-inch diameter ring on one end so that it can easily be attached to the load hook for Task 2); chain length measured from bottom of load hook
- PVC pipe, white, 1½ in. (SCH 40), sufficient to make 34 (+2) three-foot-long poles and 2 (+1) one-foot-long poles
- ¾-inch, CDX-grade (or better) plywood or high density polyethylene (HDPE)*, sufficient to create 38 pole bases, each 1½ in. (± ½ in.) × 12 in. × 12 in. (nominal)
- 38 (+3) tennis balls
- 38 (+3) feet of nylon string, to attach tennis balls to poles (optional)
- 76 (+6) 1¼-inch, zinc-plated (galvanized) screws or equivalent to secure nylon string to tennis balls and poles (optional)
- 300 ft. string line, brightly colored (for Corridor and Test Site Layout use) **NOTE: chalk line may NOT be used**
- Spirit level to verify levelness (minimum 1 ft. length)
- Paint (orange or red) for painting the tops of the poles and chain **NOTE: colored tape may be used for the poles**
- Rubber mats or paint to mark the circular Designated Areas
- 2 in. wide (minimum) clearly visible, durable tape or paint to mark the Designated Area 4
- Handheld wind speed indicator (anemometer)
- Two 45 ft. tape measures (minimum)
- Stopwatches and clipboards for Examiner(s) and Proctor(s)
- Two-way communication devices for top seat operator station (optional)
- If using remote controls, sufficient batteries to conduct all Practical Exams
- Spray paint to mark dig task

*EQUIPMENT SOURCES

NCCCO does not endorse or recommend specific vendors of any equipment, but the following source may help you find required materials and equipment:

- **HDPE bases:** House of Plastics (part number HOP01-055), 2580 S. Orange Blossom Trail, Orlando, FL 32805, 407-843-3290, plastics@hopu.com



Site Report

PRACTICAL EXAMINATION—DIGGER DERRICKS

NCCCO has established specific conditions and guidelines that each Practical Examination Test Site must adhere to. This *Site Report* is designed to ensure these conditions are met. The Examiner is required to perform a site inspection prior to the start of the first examination and complete the *Site Report* form. The Examiner must arrive at the Test Site in sufficient time to verify, by measuring with a tape, the accuracy of the course layout with respect to the NCCCO Test Site Layout (CAD). The Examiner must also conduct a visual inspection of the digger derrick for proper setup prior to testing any applicant. This *Site Report* must be presented on demand to any Practical Test Auditor.

If using more than one course at this test site, please fill out a Site Report for each course.

Please type or print neatly.

TEST SITE	DATE
NAME OF TEST SITE COORDINATOR	

Check the following items for compliance:

PRE-TEST CANDIDATE BRIEFING AREA

A suitable location for the Pre-Test Briefing of exam candidates, including:

- Sufficient tables and chairs to seat all candidates for the Pre-Test Briefing
- A DVD player and television or computer for candidates to watch the CCO Practical Exam presentation
- A location so that waiting candidates are unable to observe other candidates being tested

Candidate materials available:

- A written description of the examination (*Candidate Handbook*)
- A plan view of the Test Site Layout (CAD)
- Operator's manual and load chart(s) for all digger derricks that will be used for testing

TEST SITE SETUP

- Available area to dig at least 6 ft. into ground
- Verify that site is suitable for digging (Call "811" or other appropriate utility location service)
- Corridor has no more than a 6 in. maximum change in elevation and is free of vegetation
- Test Site is free of debris, stored materials, surface irregularities, or hazards such as overhead power lines that could interfere with test maneuvers
- No obstructions are within 5 ft. of the test course in any direction

Using the Test Site Layout (CAD), verify the following measurements:

- Distance from the center of rotation (CoR) to the center of Designated Area 1 (DA-1) is 22 ft. (± 1 in.)
- Distance from the CoR to the center of DA-2 is 16 ft. (± 1 in.)
- Distance from the CoR to the center of DA-3 is 16 ft. (± 1 in.)
- Distance from the CoR to the center of DA-4 is 11 ft. (± 1 in.) for CADs #1, #2, or #3 or 16 ft. (± 1 in.) for CAD #4
- Distance from center of DA-4 to the center of DA-5 is 5 ft. (± 1 in.)
- Distance from DA-2 to DA-3 is 22 ft., 7½ in. (± 1 in.)
- Distance from the CoR to the Far Corner (FC) is 26 ft., 2 in. (± 1 in.)
- Width of Corridor is 5 ft. ($\pm ½$ in.)
- Length of each outside leg of Corridor is 16 ft. (± 1 in.)
- Length of each inside leg of Corridor is 11 ft. (± 1 in.)
- Distance between consecutive poles (center-to-center) is 2 ft. ($\pm ½$ in.)

SITE REPORT (CONT'D)

PRACTICAL EXAMINATION—DIGGER DERRICKS

Test Site #: _____

PAGE 2 of 3

PVC POLES

- 34 (+2 replacement) poles, made of 1½ in., white PVC pipe (SCH 40), each 36 in. long with top 12 in. painted or taped orange or red (one inside splice per 3 ft. pole permitted; outside splices of PVC pipes NOT permitted; see page 23 for illustration)
- 2 poles (+1 replacement), made of 1½ in., white PVC pipe (SCH 40), each 12 in. long with top 2 in. painted or taped orange or red
- Mounted to a platform made of two layers of ¾-inch, CDX-grade (or better) plywood or high density polyethylene (HDPE), cut into nominal 12 in. squares
- A taut, longitudinal string line placed on the ground under the centerline of each pole base, per CAD. A cut concrete line may be used in lieu of a string line; no other materials are acceptable.
- 36 (+ 3 replacement) tennis balls

DESIGNATED AREAS

- Clearly marked CoR
- DA-1 is clearly marked and visible to candidate (e.g., may use spare pole base)
- DA-2 and DA-3 have outside diameter of 4 ft.
- DA-4 is a 10 ft. x 7 ft. box, with horizontal line to mark pole butt location
- DA-5 correctly built in accordance with TSCH-P (opening facing CoR)
- Clearly visible perimeter line (2 in. minimum width), marked inside DA-2, DA-3, and DA-4.
- Clearly marked area for Dig Hole Task
- If marking circles, designated areas, or other parts of a course on plywood or mats, the borders must be marked with materials with a flat, uniform surface and a lip variance not to exceed ¾ in. Any materials used may not interfere with the free movement of the pole bases.

CHAIN FOR TASK 2

- 36 in. length of 3/8- or 5/16-inch chain, painted red or orange (recommend using a minimum 6-inch diameter ring on one end that can be easily attached to load hook); measure from bottom of load hook (36 in. +/- one chain link)

TEST WEIGHT

- Gross weight of minimum 400 lb., verified by a weight ticket, crane's load indicating device (LMI, RCI, RCL), or other type of certification documenting the actual load weight available to the Examiner
- Cylindrical in shape with no protruding edges
- The outside diameter of the Test Weight is 2 ft.
- Between 2 ft. and 4 ft. in overall height (including feet and attachment points)
- Method of attachment: Test Weight rigging has two or three sling legs, 2–4 ft. in length (load-bearing point to load-bearing point), and is attached to the top inside of the Test Weight
- A length of 3/8- or 5/16-inch chain extending from the bottom center of the Test Weight
*To measure the chain length, attach the Test Weight to hook. Raise the Test Weight until the chain barely touches the ground and measure from the lowest edge of the Test Weight to the ground. **This length must be 36 in.***
- Chain is painted orange or red

SITE REPORT (CONT'D)

PRACTICAL EXAMINATION—DIGGER DERRICKS

Test Site #: _____

PAGE 3 of 3

UTILITY POLE

- Facing correct direction based on CAD selection and pole butt in center of DA-4
- Between 35 ft. and 45 ft. in length
- Maximum 18 in. pole butt diameter
- Made of wood
- Painted or marked pick point (see TSCH-P for selecting pick point)
- Method of attachment is choked synthetic sling with a maximum of 36 in. from choke point to hook
- Cradle under top of pole, with minimum 3 in. clearance (e.g., two wheel chocks)

RIGGING (TEST WEIGHT AND UTILITY POLE)

- All load-supporting components must be assembled in accordance with proper rigging practice and working load limits for the hardware utilized (e.g., ASME B30)

TEST COURSE SETUP

- The Practical Examiner whose signature appears at the end of this Site Report attests that he/she has set up the course. (Check only if the Practical Examiner has set up the test course.)
- The Examiner must have the following items for conducting the Practical Exam:
 - Two stopwatches
 - Clipboard
 - Anemometer (wind meter)
 - Pen
 - Spirit or digital level
 - 2 measuring tapes (45 ft. minimum)
 - Test Site Layout (CAD)
 - Proctor
 - Verbatim instructions
 - Notification of test email (new test sites if applicable)
 - Personal protective equipment
 - Two-way communication devices (for top seat operator's station), optional
 - Visible marking paint

Deviations from the above-noted requirements are not allowed without written consent from the NCCCO Western Regional Office.

PRACTICAL EXAMINER ATTESTATION (EXAMINER SIGNATURE REQUIRED.)

I attest that this is a true and accurate report of the above named Test Site.

SIGNATURE OF EXAMINER	DATE
PRINTED NAME OF EXAMINER	EXAMINER ACCREDITATION NUMBER

This Site Report is to be completed by the Examiner prior to each testing session and sent with candidate score sheets to:

NCCCO—Testing Services Department
1960 Bayshore Blvd.
Dunedin, Florida 34698

Phone: 727-449-8525
Fax: 727-461-2746
Email: info@nccco.org

This page intentionally left blank



Digger Derrick Report

PRACTICAL EXAMINATION

NCCCO has established specific safety conditions and guidelines that each practical exam must follow. This Digger Derrick Report is a verification tool used to ensure that all testing parameters are within strict, safe working conditions. Before testing is conducted, the digger derrick being used for testing must have its own unique report filled out. This report should be completed in ink, signed by the Examiner, and sent with the Site Report to: NCCCO—Testing Services Department, 1960 Bayshore Blvd., Dunedin, FL 34698.

REMINDER: Each digger derrick used must have a separate report filled out.

TEST SITE NUMBER		DATE
NAME OF TEST SITE COORDINATOR		NAME OF PRACTICAL EXAMINER
DIGGER DERRICK OWNER/COMPANY NAME		
DIGGER DERRICK OWNER/COMPANY POINT OF CONTACT		PHONE NUMBER
MAKE & MODEL OF DIGGER DERRICK		SERIAL NUMBER OF DIGGER DERRICK
MAX. BOOM RADIUS (FT.) (JIBS MAY NOT BE USED)	AUGER DIAMETER (IN.)	FLIGHT HEIGHT (FT.)
MAX. RATED CAPACITY (LB.)	FRONT OUTRIGGER WIDTH (FT.)*	REAR OUTRIGGER WIDTH (FT.)
BOOM MOUNT LOCATION <input type="checkbox"/> Rear Center <input type="checkbox"/> Behind Cab <input type="checkbox"/> Corner		

*MEASURE FROM OUTSIDE EDGE TO OUTSIDE EDGE

EXAMINER CHECKLIST:

- Verify digger derrick has a current annual/comprehensive inspection or initial inspection if the unit has not been in service for more than 12 months; all supporting documentation must be in accordance with OSHA standards
- Complete a pre-operational shift inspection to verify no deficiencies are present that would affect safety or performance
- Set up and leveled in the location specified on the CAD, ready for operation in accordance with the manufacturer's recommendations
- All outriggers properly set per manufacturer's recommendations (intermediate, mid, or short-span outriggers not permitted)
- Blocking or cribbing, as necessary, to provide sound foundation
- No jib installed
- Pole guides installed and functioning
- Auger properly installed and stowed on the side of the boom
- If using remote control, sufficient batteries on hand to conduct all practical exams

See reverse side to complete Digger Derrick Report.

DIGGER DERRICK REPORT (CONT'D)

TEST SITE LAYOUT USED: DDO #1 DDO #2 DDO #3 DDO #4

VERIFYING CAPACITY FOR TEST WEIGHT TASK (FOR ALL TEST SITE LAYOUTS)

Provide the lowest capacity rating at a 27 ft. radius:

BOOM RADIUS (ft.)		LOAD CHART RATING (lb.)		× .75 =	
<input style="width: 100%;" type="text"/> ft.		<input style="width: 100%;" type="text"/> lb.			<input style="width: 100%;" type="text"/> lb.
GROSS LOAD (TEST WEIGHT + RIGGING) =					<input style="width: 100%;" type="text"/> lb.

VERIFYING CAPACITY FOR POLE TASK (FOR DDO #1, #2, OR #3)

Provide the lowest capacity rating at a 17 ft. radius:

BOOM RADIUS (ft.)		LOAD CHART RATING (lb.)		× .75 =	
<input style="width: 100%;" type="text"/> ft.		<input style="width: 100%;" type="text"/> lb.			<input style="width: 100%;" type="text"/> lb.
GROSS LOAD (LIFTING POLE + RIGGING) =					<input style="width: 100%;" type="text"/> lb.

VERIFYING CAPACITY FOR POLE TASK (FOR DDO #4)

Provide the lowest capacity rating at a 22 ft. radius:

BOOM RADIUS (ft.)		LOAD CHART RATING (lb.)		× .75 =	
<input style="width: 100%;" type="text"/> ft.		<input style="width: 100%;" type="text"/> lb.			<input style="width: 100%;" type="text"/> lb.
GROSS LOAD (LIFTING POLE + RIGGING) =					<input style="width: 100%;" type="text"/> lb.

NOTE: *Gross Loads used must be less than Maximum Allowable Gross Loads calculated above.*

I attest that this is a true and accurate report of the digger derrick and test weight being used for testing.

EXAMINER SIGNATURE

PRINTED NAME OF EXAMINER

EXAMINER'S ACCREDITATION #

DATE



NCCCO Information Release Policy

A. Definitions

1. "NCCCO" means and refers to the National Commission for the Certification of Crane Operators acting through its staff and authorized agents and representatives.
2. "Releasable Information" means and refers to the following information: name, certification status, examination dates, certification dates, certification number(s), and designations. In the case of accredited Practical Examiners, "Releasable Information" also means and refers to the following information: name, accreditation status, accreditation dates, accreditation number, and categories in which the Practical Examiner is authorized to administer exams.
3. "Third Party" means and refers to an employer, prospective employer, regulatory agency, or any other person or entity that makes an inquiry to NCCCO.

B. Policies

1. It shall be the policy of NCCCO to provide Releasable Information pertaining to individuals who have successfully passed one or more NCCCO examinations. It shall also be the policy of NCCCO to provide Releasable Information pertaining to such individuals on its website using such protocols as may be established. In addition, it shall be the policy of NCCCO to provide information, as appropriate, concerning individuals who have been sanctioned, suspended or revoked from participation in NCCCO's programs, using such protocols as may be established.
2. Releasable Information may be released to a Third Party who makes a written request, including by electronic correspondence. Generally, Releasable Information will be released within one business day from actual receipt of a written request.
3. If a Third Party requests information concerning an individual who has not taken or successfully passed an NCCCO examination, NCCCO may release a statement confirming that, as of a given date, the individual does not appear on NCCCO's list of successful candidates in one or more categories of certification.
4. If an applicant or certificant is under formal sanction, suspension, or revocation by NCCCO, then NCCCO may release a statement to that effect to any persons and by any reasonable means, including by means of a list published on the NCCCO website. In addition, if an individual applicant or certificant is under formal investigation, sanction, suspension, or revocation by NCCCO, then NCCCO may release a statement concerning the status of the applicant or certificant to any Third Party and to any jurisdiction that requires or accepts CCO certification as a basis for satisfying

requirements to work in the jurisdiction. Any such statement to a Third Party or jurisdiction may identify the applicant or certificant, the certifications affected, the actions taken, and the effective dates of any such actions.

5. If an accredited Practical Examiner, authorized Test Site Coordinator, listed Training Provider, or other authorized participant in NCCCO's programs ("Authorized Participant") is under formal sanction, suspension, or revocation by NCCCO, then NCCCO may release a statement to that effect to any persons and by any reasonable means, including by means of a list published on the NCCCO website. In addition, if an Authorized Participant is under formal investigation, sanction, suspension, or revocation by NCCCO, then NCCCO may release a statement concerning the status of the Authorized Participant to any persons and by any reasonable means, including by means of a list published on the NCCCO website. Any such statement may identify the Authorized Participant, the credentials or capacities affected, the actions taken, and the effective dates of any such actions.
6. If a Third Party seeks information other than the foregoing information, generally, absent a subpoena or similar legal process, such information will not be released. However, in the course of business, as circumstances reasonably warrant, NCCCO reserves the discretion to release information other than the foregoing information.
7. Certain situations may require or warrant the immediate verbal confirmation of an individual's certification status or other Releasable Information in response to a written or verbal request. Under such circumstances, NCCCO may provide such immediate verbal confirmation, at its discretion. When such a verbal confirmation is provided, it shall be NCCCO's policy to follow up with a written confirmation.
8. It shall be the policy of NCCCO to discuss score-related and test-specific matters only with a candidate or a candidate's authorized legal representative.
9. NCCCO will release Releasable Information about an individual upon receipt of a written request (including electronic correspondence) from that individual. NCCCO may release information other than Releasable Information about an individual, at its discretion, upon receipt of a signed, notarized, written request from that individual. In addition, NCCCO will release information other than Releasable Information about an individual when required by a legal authority of competent jurisdiction under a duly-issued subpoena, subject to any objection, or as otherwise required by law.



Summary of Changes

TEST SITE COORDINATOR HANDBOOK—DIGGER DERRICKS

Following approval by the appropriate NCCCO committees, Commissioners, and/or Board of Directors, the following substantive (non-editorial) changes have been made to the *Digger Derrick Test Site Coordinator Handbook* (major programmatic changes covered in Test Site Coordinator Bulletins are in **bold**):

Changes made 08/18:

<i>Page(s)</i>	<i>Section</i>	<i>Change</i>
5	Permanent Test Sites	<ul style="list-style-type: none"> Added that an annual full site report is required for permanent test sites.
23, 25	Pole Barrier Construction	<ul style="list-style-type: none"> Removed requirement to use screws to attach string to poles and tennis balls
35	Site Report	<ul style="list-style-type: none"> Added that the Corridor must be free of vegetation.

Changes made 03/18:

<i>Page(s)</i>	<i>Section</i>	<i>Change</i>
5, 20	Score Reporting	<ul style="list-style-type: none"> Test Site Coordinators now automatically receive Pass/Fail Reports for both written and practical exams at no charge. A Pass/Fail Report Request Form is no longer required to be submitted.
13	Candidate Application	<ul style="list-style-type: none"> Updated Candidate Attestation Statement
16	Practical Test Administration Summary Form	<ul style="list-style-type: none"> Moved \$50.00 fee for Detailed Score Report Request from mandatory to optional charge.
41	Information Release Policy	<ul style="list-style-type: none"> Added the NCCCO Information Release Policy

Changes made 09/17:

<i>Page(s)</i>	<i>Section</i>	<i>Change</i>
9, 11, 13, 22	Test Site Coordinator Forms	<ul style="list-style-type: none"> Updated return address to NCCCO's new Murray, UT, address
17-18	Practical Test Administration Summary Form	<ul style="list-style-type: none"> New form must be returned along with all candidate applications, fees, photos, and score sheets
25, 38	Poles	<ul style="list-style-type: none"> Added that a cut concrete line may be used in lieu of a string line; no other materials are acceptable.

IMPORTANT CONTACT INFORMATION



NATIONAL COMMISSION FOR THE CERTIFICATION OF CRANE OPERATORS

2750 Prosperity Avenue, Suite 505
Fairfax, VA 22031-4312

Phone: 703-560-2391

Fax: 703-560-2392

Email: info@nccco.org

Website: www.nccco.org



**NATIONAL COMMISSION FOR THE
CERTIFICATION OF CRANE OPERATORS**

2750 Prosperity Avenue, Suite 505
Fairfax, VA 22031-4312

Phone: 703-560-2391

Fax: 703-560-2392

info@nccco.org

www.nccco.org